

产品使用说明书

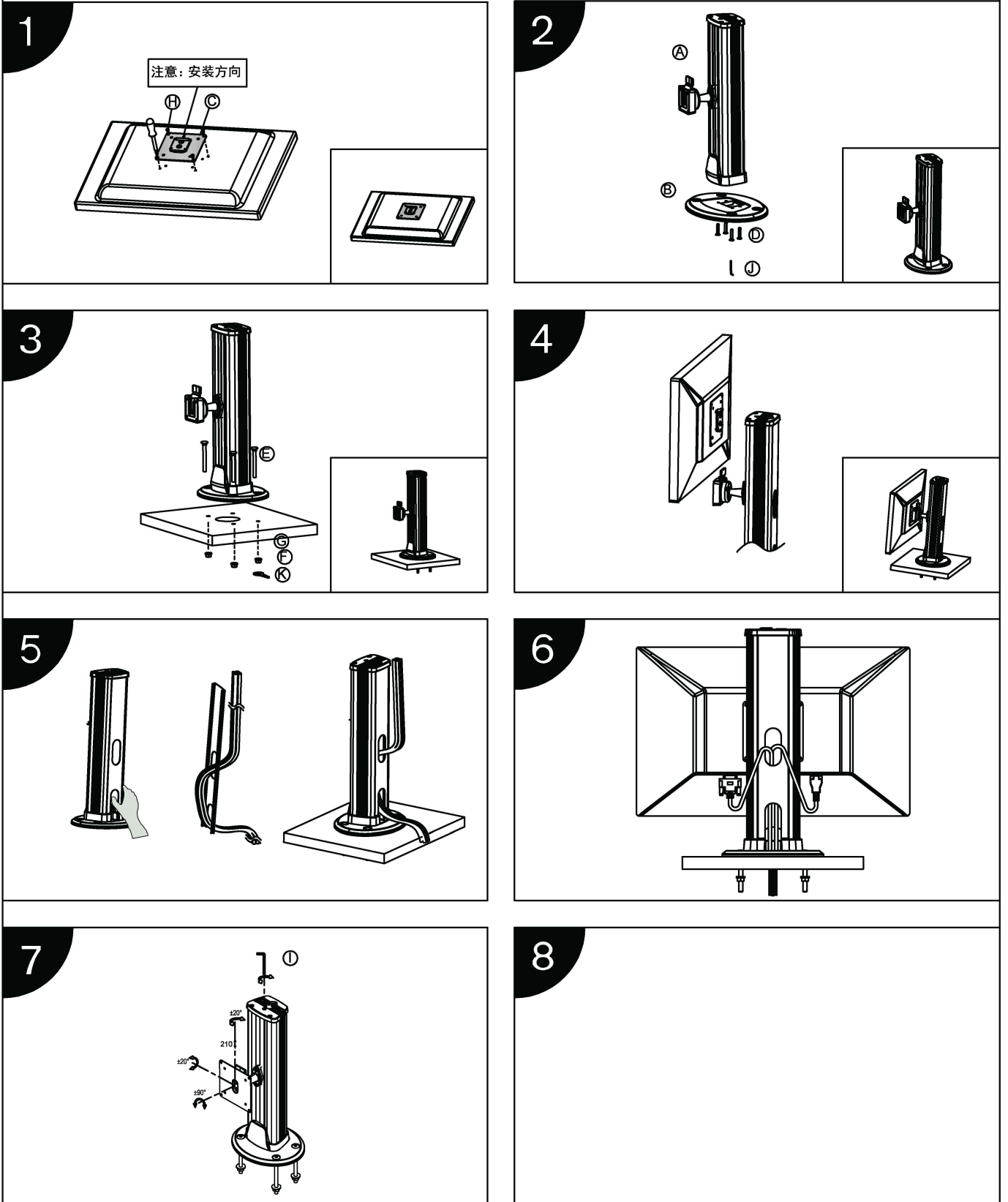









产品型号：CL100

安装步骤



产品使用说明书

产品型号：CL100

标准配件			
序号	示图	规格	数量
A		CL0501	1
B		CL0601	1
C		S100-1000	1
D		M5*25	4
E		M8*80	4
F		M8螺帽	4
G		M8垫片	4
H		M4*12	4
I		M5	1
J		M3	1
K		E-FE-16	1