

产品使用说明书

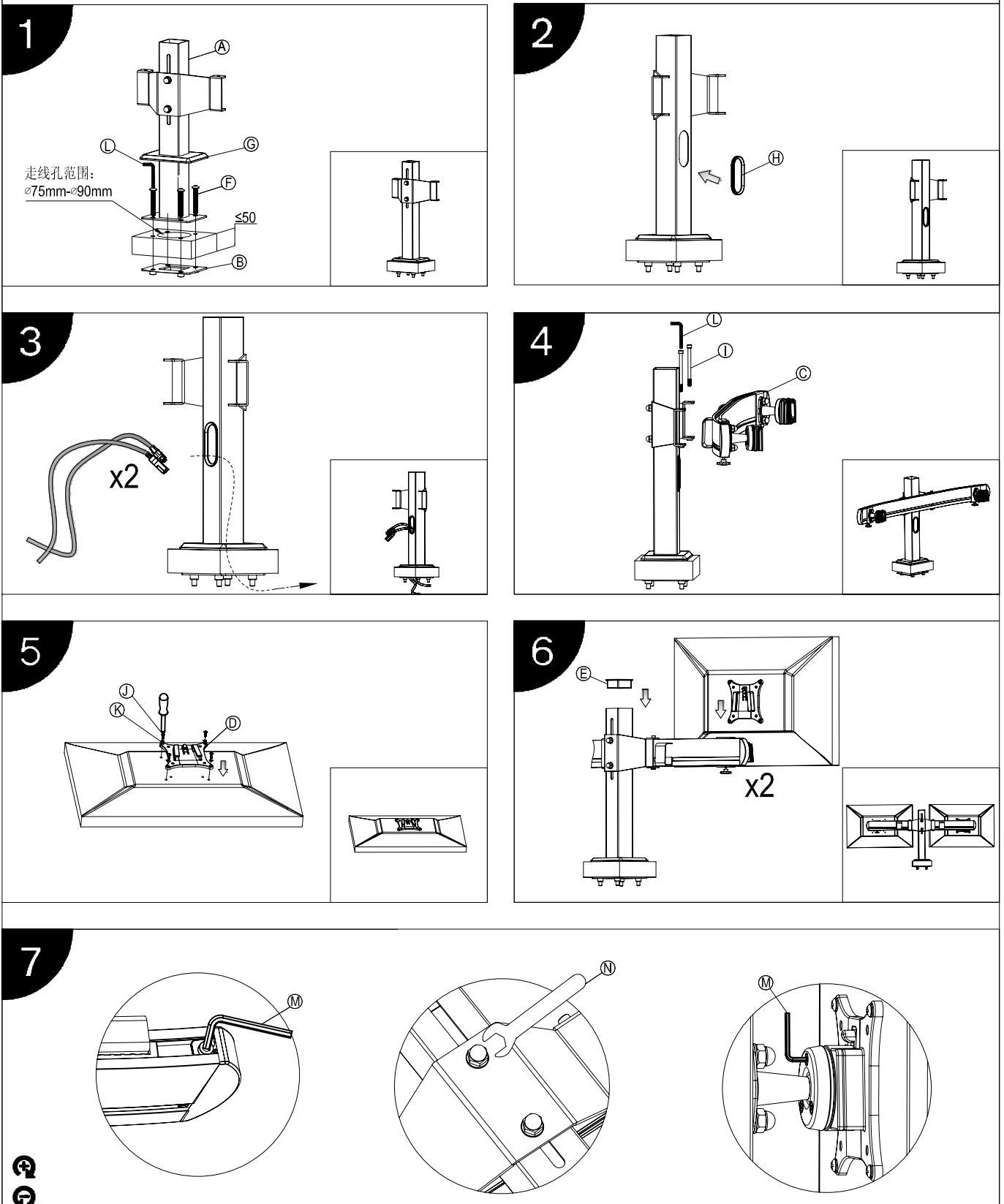









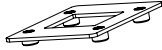

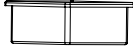
产品型号: BL203

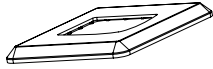
安装步骤

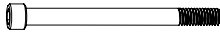

产品使用说明书

产品型号: BL203

标准配件			
序号	示图	规格	数量
A			1
B			1
C			1
D			2
E			1
F		M8*65	4
G			1
H			1
I		M6*80	2
J		M4*12	8
K		M4	8
L		M5	1
M		M3	1
N		M8	1