

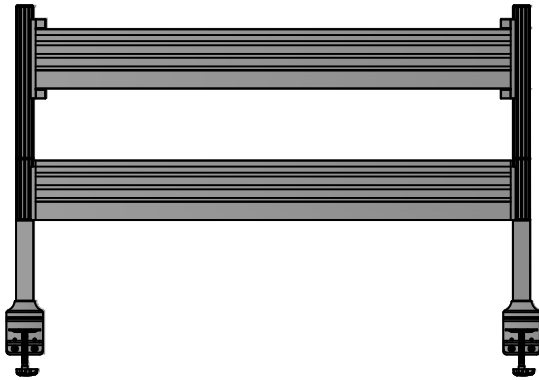





## Installation Manual

### Model No: PF-B

#### PF-B

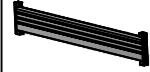

#### Parts list

No.	ITEM	SPECS	QUANTITY
A			2
B			1
C			1
D		M8	1
E		M6	1
F		M5	1
G		M4	1

1

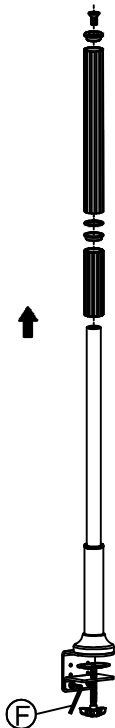

2

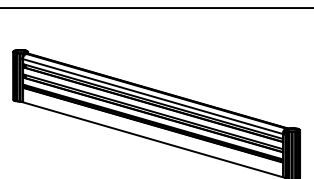
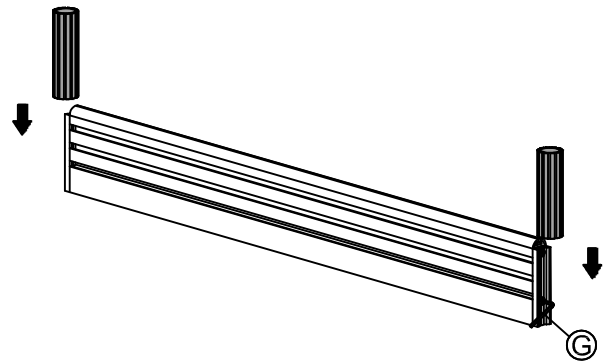

## Installation Manual

### Model No: PF-B

